

Single-Sided Media Frame DF 1052 PROFILE

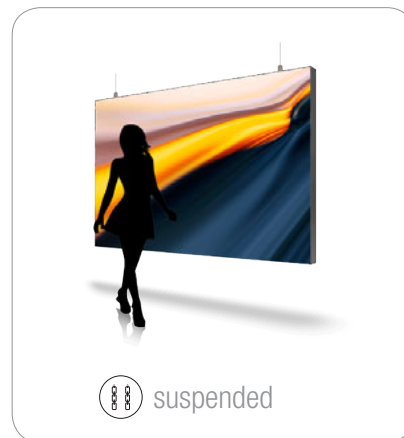

The DF 1052 proposes the same bold 4.4-inch extrusion as the DF 1051 but with a 90-degree frame.

MOUNTING OPTIONS

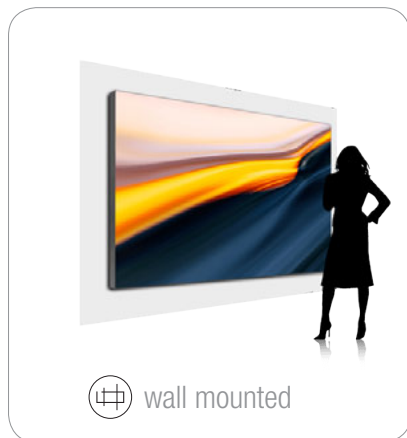

MEDIA PRINT & DISPLAYS
GRAPH
June, 2020

300 Montee de Liesse - Saint-Laurent, QC H4T 1N9 - Tel: 514-858-6556 - Fax: 514-858-7667 www.media-graph.com

PROFILE

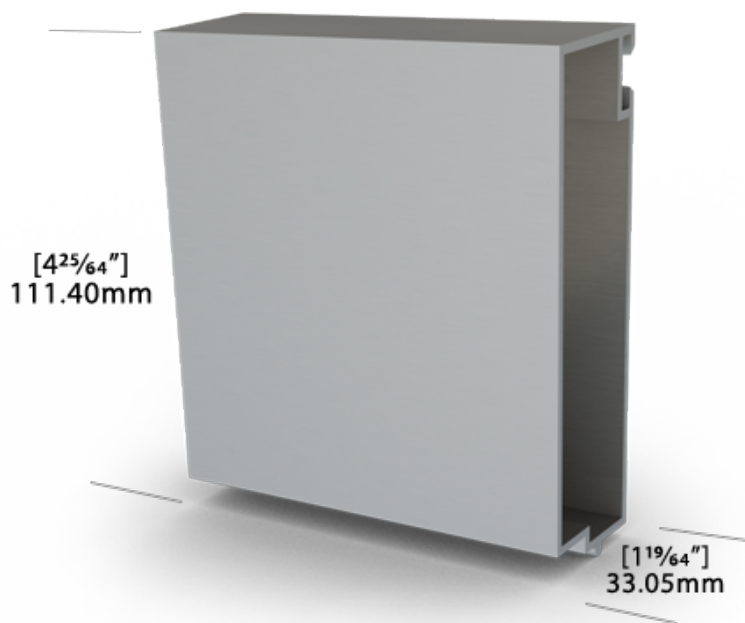

PACKAGING

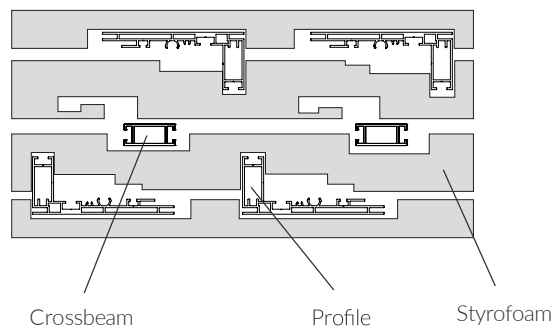

HARDWARE

DISPLAY SIDES	single-sided
INDOOR / OUTDOOR	indoor
SEG LOADING METHOD	frontal
CUSTOM SIZES	yes
PROFILE FINISH	Clear Anodized or any RAL# (other colors upon request)
COLLAPSIBLE	yes

TEXTILE

MEDIA TEX MATTE	Non-glare matte knit polyester fabric. (usage: Non-Lit Media Frames, Banners, General Textile Graphics)
MEDIA LIGHT	Medium-weight matte finish polyester fabric with built-in diffuser layer. (usage: Lightboxes)

1. File types accepted (placed in order of preference)



EPS, TIFF, PSD

Provide a flattened image at real size.
No bleed is required unless you have text close to the edge of your artwork.



PDF

Provide a high print quality resolution PDF.
No bleed is required unless you have text close to the edge of your artwork.



INDD, PDF

Always provide a file with links for fonts, and images (Packaged).



AI, EPS

Fonts must be rasterized and links for the images must be provided.

* Please provide a PDF or JPEG reference at all times.
As well as references to calibrate PMS printing.
Always confirm the final format printing.

2. File details



Fonts

All fonts should be rasterized, or provide links to your fonts.



Colors

Preferably, your files should be in RGB mode or Pantone colors, CMYK is accepted. For a deep black, we recommend the following distribution:
30% Cyan, 30% Magenta, 30% Yellow, 100% Black.



Final file submission

All final files should be at the printing dimensions and at 120 dpi. If your files are less than the required resolution, let us help make the changes if necessary.

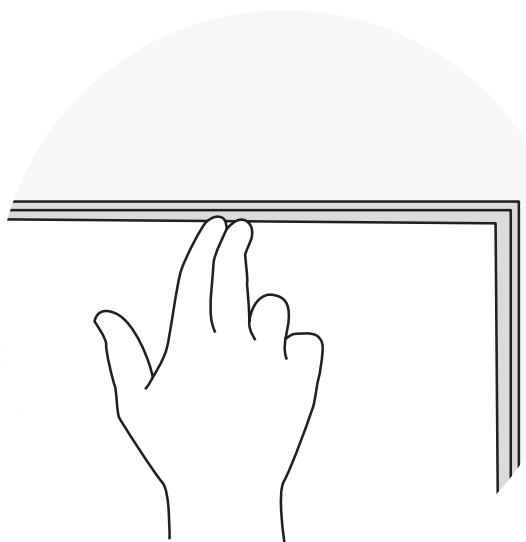
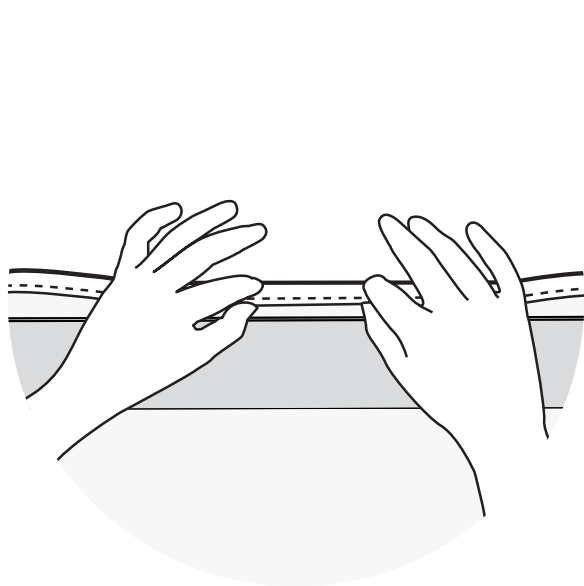
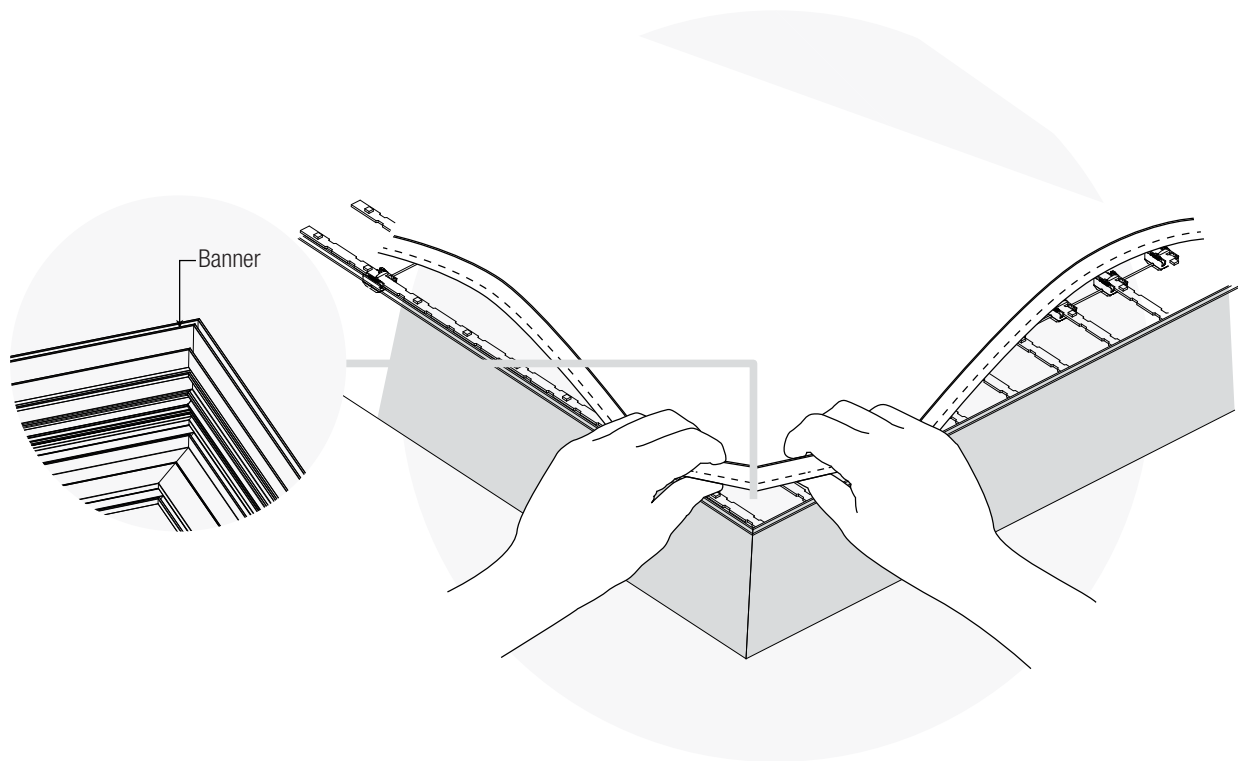



Our “Under One Roof” philosophy enables our in-house team to quickly offer the best solution for your turnkey projects.



PRE-PRESS

Media Graph's creative and professional design department is equipped with the latest resources and graphic applications to prepare your files for large format printing.



ALUMINIUM

We design the shape of every custom-made piece of aluminum to make sure our projects meet your exact requirements and use the assistance of high-tech machinery to produce and assemble everything under one roof. Our in-house metal shop incorporates a wide variety of equipment for the fabrication of aluminum, sheet metals, and heavy metals. From cutting, forming, folding, and welding to milling and machining, we have the state-of-the-art tools to get the job done promptly and efficiently.



ACRYLIC

At Media Graph, every custom project we manufacture is produced under one roof, including working with acrylic. We fine-tuned our engineering methods with our laser cutters and CNC routers, making our projects attractive, clean, and ready to assemble.



PAINT

Our paint shop is yet another value-added service that Media Graph provides. Advanced techniques and premium materials allow us to control all aspects of our production process.



FINISHING

Employing a wide range of the most advanced laser cutting equipment on the market allows us extremely accurate cutting on a wide variety of materials such as fabrics, textiles, wood, acrylics, and more. Our in-house sewing facility works with other departments to ensure quality finishing through the use of SEG (Silicone Edge Graphics).



ASSEMBLY

Continually innovating the most efficient and precise methods of framing production and assembly, we identify and utilize the most accurate construction techniques for each project. Our solutions translate into substantial cost savings on both shipping and installation for our clients.



LOGISTICS

Our logistics department is ready to handle anything from the simplest shipments to large, drop-ship rollouts. Whether shipping locally or nationally, our team is experienced in delivering your products worry-free and on time.



INVENTORY

We maintain a vast inventory of custom extrusions and quality materials. Engineering our solutions under one roof to ensure that all of the components, from fabric and frames to lighting and electrical systems work together as efficiently as possible.



QUALITY

We achieve our premium standards of efficiency and efficacy with an intensive Quality Control process. Always innovating and improving existing products to ensure we are providing our clients with the exact product that fits their needs.



DEVELOPMENT

Continually developing new products and updating existing ones, our goal is to provide our clients with solutions to their obstacles. We research and perform in-house tests on color matching, durability, and LED parameters providing the highest quality products.



TESTING

Remaining on the leading edge of technology, we operate and maintain an advanced laboratory allowing us to test thoroughly and study all of the components that go into our manufacturing process. This technology ensures that we offer a superior product to our clients.



PRODUCTION

At Media Graph, every illuminated product we produce is custom wired in-house to meet the requirements of each project. We designed our production methods to feature clean lines and hidden wiring and are continually striving on ways to simplify installation in the field.



QUOTING

At Media Graph, we have a Rapid Support team to ensure quick estimations and same-day quoting.